



Impact protection systems

ELEKTRON sp. z o.o. sp.k. / 38-462 Kobylany, Sulistrowa 33 , Poland /+48 13 307 03 03/
laser@web-elektron.pl , biuro@web-elektron.pl /www.web-elektron.pl

ABOUT US

Our company provides comprehensive services in the field of laser cutting, sheet metal bending, welding, drilling and threading. We are a young company with professional knowledge that helps us solve even the most difficult problems.

CONTACT



WE INVITE YOU TO CONTACT:

ELEKTRON sp. z o.o.



Customer service hours:



Monday - Friday, 7:00 am - 4:00 pm

38-462 Kobylany, Sulistrowa 33



CUSTOMER SERVICE OFFICE

+48 13 307 03 03



SHEET LASER CUTTING:

laser@web-elektron.pl



OFFICE:

biuro@web-elektron.pl



www.web-elektron.pl



NIP: 6842640074



REGON: 360939126



KRS: 0000749874

CONTENT

INTRODUCE	1
Steel Bollards	2
Tubular Protection Guards	5
Stainless Steel Floor Rail	8
Steel Hoop Safety Guards	11
Collision Protection Bars	14
Wheel guides	17
Overhead Clearance Bars	20
Corner Tubular Protection Guard	22
Column & Post Protectors	29
Vertical Pipe Protectors	32
Pallet Racking Protectors	35





Manufacturer of industrial bollards

ELEKTRON sp. z o.o. sp.k. provides comprehensive services in the field of laser cutting, sheet metal bending, welding, drilling and threading. such as balustrades and safety bollards. We have over 9 years of experience in metal fabrication. Comprehensive, professional service and the highest quality products are our priority.

Impact protection systems

Our barriers comply with all of today's Health & Safety regulations. As well as protecting racking, our barriers can be used to segregate and protect forklift truck battery chargers, vending machines, conveyors, factory or warehouse offices.

They can also demarcate busy areas and danger zones, such as pedestrian areas and doorways.

Safety barriers and barricades can be used for a variety of everyday applications to prevent harm. They can be used for quick and effective pedestrian, traffic and crowd protection. Barriers stand in the way to protect you from dangers!

Special offers include industrial fenders of various types, from simple pole fenders to trolley fenders, corner fenders, technical barriers, linear ground fenders and many other designs and variants.

- We offer a full designs and fabrication service to meet your exact requirements.
- We invite you to familiarize yourself with our offer.



Column bumpers are most often used to protect industrial gates, fencing pedestrian and transport routes, to protect vulnerable places or as machines and demarcation lines. They are usually found in warehouses, production plants, reloading docks, etc. They provide basic protection against the impact of moving vehicles.

All Safety Bollards are yellow painted surface with strips of reflective foil. Bumpers effectively protect storage racks, production line machinery and equipment, as well as structural elements of industrial halls. Fenders mounted to the ground by screwing.

The pole fenders are made of high quality steel. The products have a yellow varnished surface additionally marked with black reflective film strips. The end of the fender is permanently blanked with a welded steel plug. Buffers provide security for storage racks, production line machinery and equipment as well as structural elements of industrial halls.

Steel bollards

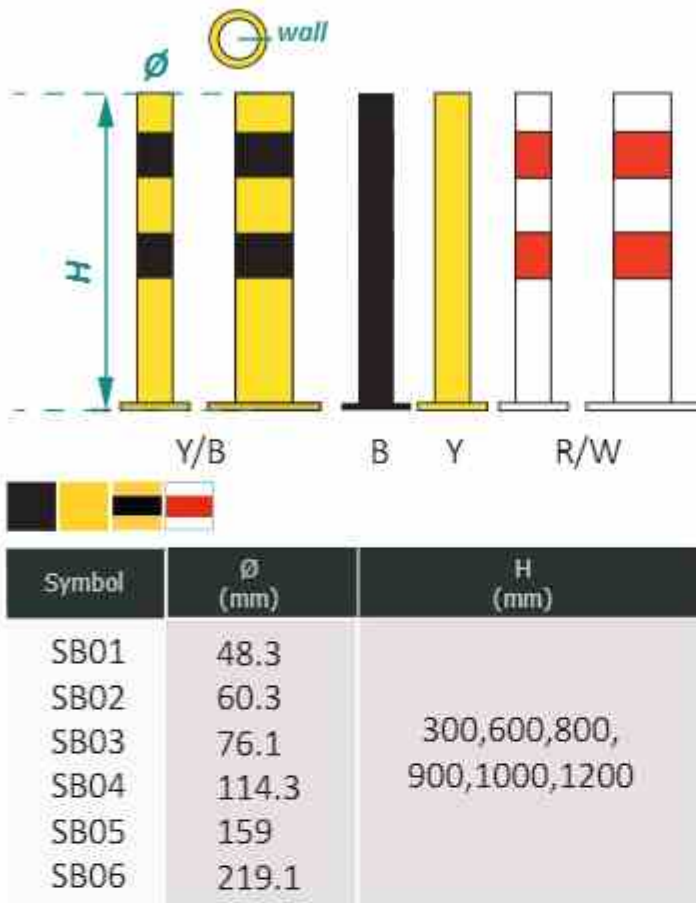

Key features:

- Material: black steel
- Coating: painted by method powder yellow with black reflective strips
- Installation: ground fastening with 12mm screws or 12mm anchors
- Base thickness: 8 mm with dimensions -120x120 mm (Ø48.3; Ø60.3), 140x140 mm (Ø76.1), 200x200 mm (Ø114.3), 250x250 mm (Ø159), 300x300 mm (Ø219.1)

Stainless steel bollards

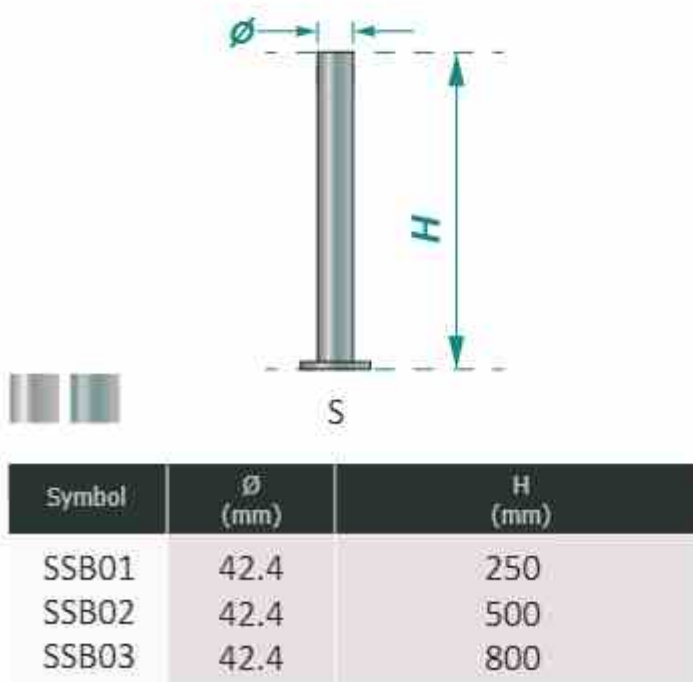

The stainless steel bollard is used in stores, trade centers for cold stores etc.

Key features:

- Material: stainless steel
- Coating: painted by method powder yellow with black reflective strips
- Installation: ground fastening with 12mm screws or anchors
- Base thickness: 8 mm with dimensions -120x120 mm (Ø48.3; Ø60.3), 140x140 mm (Ø76.1), 200x200 mm (Ø114.3), 250x250 mm (Ø159), 300x300 mm (Ø219.1)





Black Bull Steel Barrier Protection Guard are suitable for use outdoors, providing a high level of protection for work areas and traffic routes.

The barriers can be quickly and easily installed with fixing bolts directly to concrete. They are ideal for the likes of warehouses, freight depots, storage facilities and many more.

Each protective hoop is made from the best quality steel and powder coated yellow for easy recognition by pedestrians, machinery users etc.

Applications : Protect stock, traffic routes and work areas, separates different traffic routes (e.g. stacker lanes in warehouses and pedestrian traffic), machinery, supports, columns, shelving, loading ramps, equipment etc.

Indoor: Powder-coated yellow with black bands.

Outdoor: Hot-Dip Galvanised and powder-coated yellow with black bands

Tubular protection guards

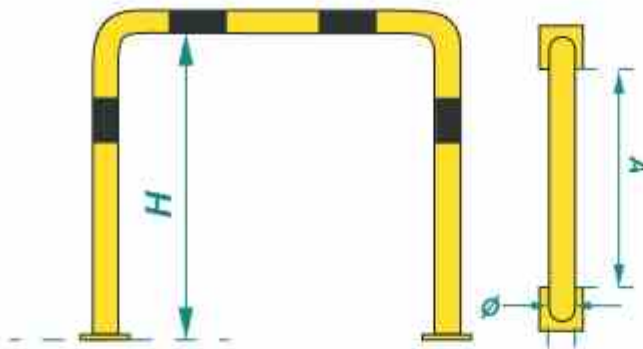

Symbol	Ø (mm)	H (mm)	A (mm)
TP-L01	60.3	400	
TP-L02	60.3	600	500,600,800
TP-L03	60.3	800	

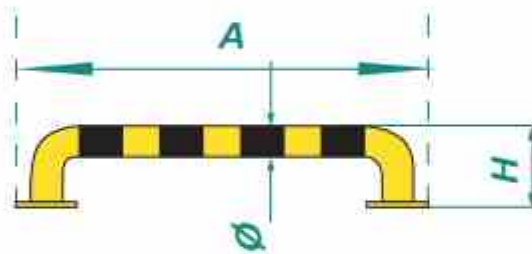

Symbol	Ø (mm)	H (mm)	A (mm)
TP-S01	60.3	120,200,300	300,350,400,450,500,600,800,1000
TP-S02	76.1	800,1000	1200,1500,2000,3000
TP-S03	114.3		

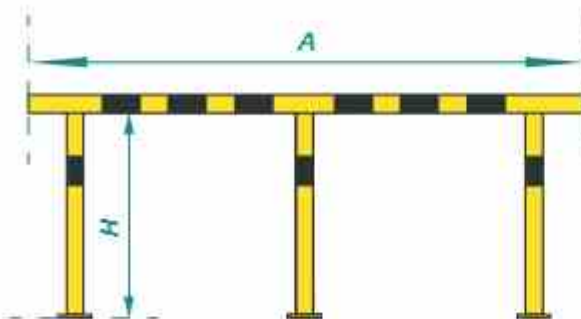

Symbol	Ø (mm)	H (mm)	A (mm)
TP-H01	60.3	120,200,300	300,350,400,450,500,600,800,1000
TP-H02	76.1	800,1000	1200,1500,2000,3000
TP-H03	114.3		

The hydrant Stop. This protects lighting poles and hydrants in parking lots. Dimensions can be to customer specification.

Key features:

- Material: black steel
- Coating: hot dip galvanized, powder painted yellow with black reflective stripes
- Mounting: fastening to the ground with 12mm screws or 12mm anchors
- Base thickness: 8 mm

Parking stops

Key features:

- Material: black steel
- Coating: hot dip galvanized, powder painted yellow with black reflective stripes
- Mounting: fastening to the ground with 12mm screws or 12mm anchors
- Base thickness: 8 mm

Fenders assembled

Key features:

- Material: black steel
- Coating: hot dip galvanized, powder painted yellow with black reflective stripes
- Mounting: fastening to the ground with 12mm screws or 12mm anchors
- Base thickness: 8 mm





The floor mounted stainless steel rail are typically mounted where your premises are most at risk from the damage caused by wheeled trolley traffic. Typical applications are in front of glazed areas, signage displays, and walls of stores. The stainless steel trolley rail is fully modular which makes them cost effective and easy to install. The stainless steel floor rail is supplied as a bolt down option as standard.

The stainless steel corner guard is designed to protect one of the most vulnerable areas of a wall from severe impact and wear, significantly reducing ongoing maintenance and repair costs.

Shop fender stainless steel

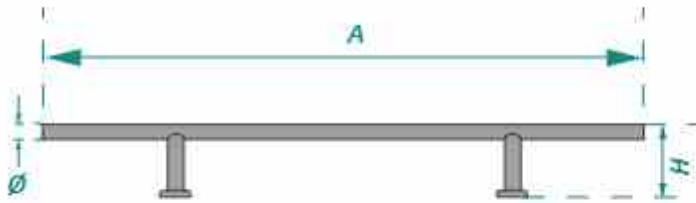

Symbol	Ø (mm)	H (mm)	A (mm)
SFS01	42.4	180	
SFS02	42.4	180	490,740,
SFS03	42.4	180	1240,1620
SFS04	42.4	180	

Stainless steel linear fender is used in shops, shopping malls, cold stores etc.

Our standard version dimensions are presented in the product data sheet.

Non-standard items can be manufactured to customers specifications

Key features:

- coating : stainless steel,
- assembly : screwed with expansion anchors.

Corner shop fender stainless steel

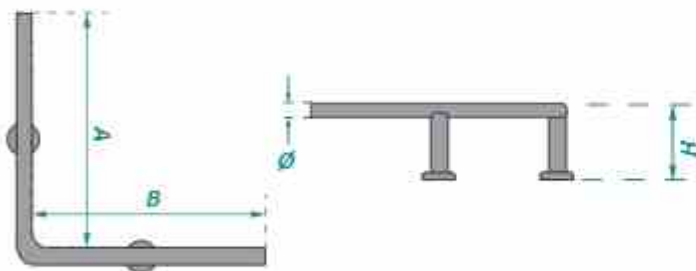

Symbol	Ø (mm)	H (mm)	A (mm)	B (mm)
CFS01	42.4	180	490	490
CFS02	42.4	180	620	620

Corner shop fender is used in shops, shopping centers, cold stores etc.

Our standard version dimensions are presented in the product data sheet.

Non-standard items can be manufactured to customers specifications

Key features:

- coating : stainless steel,
- assembly : screwed with - expansion anchors.





ELEKTRON

Steel hoop safety guards

Use steel hoop guards at your factory, warehouse, loading dock, commercial entrance or exit or in any other place where visible segregation of space is needed. Use them to separate different zones within your area, such as where vehicles and machinery go versus where pedestrians areas. This will improve safety by providing that visible warnings to advise everyone of safe working locations.

It is essential to have visibility to protect vulnerable areas of your business from accidental damage and our protection guards are the ideal way to ensure that. They are sturdy, strong protection guards which absorb the impact should an accidental bump, scrape or collision occur.

These steel hoop guards are perfect for entrance and exit areas, where heavy amounts of traffic consistently move in and around the area. Ensuring that you have a pedestrian walkway securely cordoned off is a vital aspect of maintaining safety. The eye-catching colour of these yellow and black steel hoop guards will provide clear demarcation and a strong visual impact for pedestrians and drivers.

Steel hoop guard

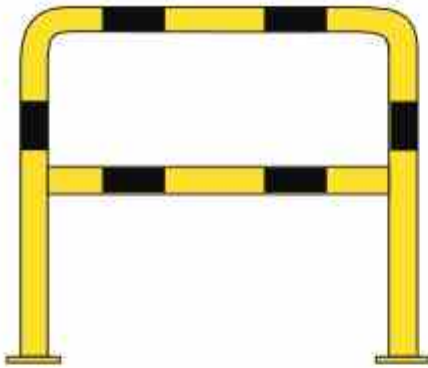

Symbol	L (mm)	H (mm)	Ø (mm)	Wall (mm)
SH01	500	900	48	4.0
SH02	1000	900	48	4.0
SH03	1200	900	48	4.0
SH04	1500	900	48	4.0

Traffic line steel hoop guard designed for protection of pedestrian areas, machinery, dangerous zones, elevation changes, loading docks and other hazardous areas.

Key features:

- Material: black steel
- Coating: hot dip galvanized, powder painted yellow with black reflective stripes
- Mounting: fastening to the ground with 12mm screws or 12mm anchors
- Base thickness: 8 mm

Permanent wall fix steel hoop guard

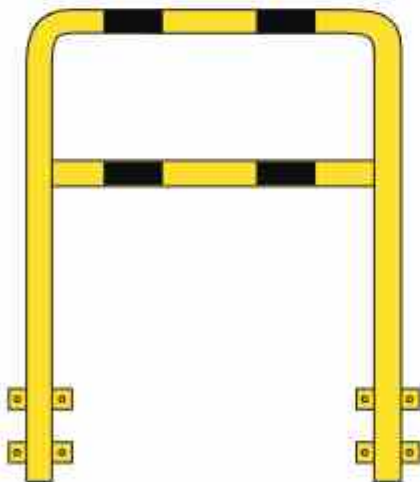

Symbol	L (mm)	H (mm)	Ø (mm)	Wall (mm)
F-SH01	1000	1300	48	4.0
F-SH02	1500	1300	48	4.0
F-SH03	2000	1300	48	4.0

Permanent wall fix steel hoop guard in Yellow/Black. Protect and segregate pedestrians from machinery spaces and other zones from work vehicles, falls etc as well.

Key features:

- Material: black steel
- Coating: hot dip galvanized, powder painted yellow with black reflective stripes
- Mounting: fastening to the ground with 12mm screws or 12mm anchors
- Base thickness: 8 mm





provide low cost protection for plant and machinery from forklift trucks, roller containers, trolleys, pallet trucks etc.

Additionally, they can be used to protect shelving and wall mounted equipment such as instruments, switch cabinets, first aid equipment etc. Due to their low profile they allow easy pedestrian access to protected areas.

Each Collision Protection Bar is made from the toughest German steel and provides excellent protection to nearby assets, especially in the likes of warehouses where frequent forklift activity or pallet trucks may be in operation.

Each collision protection bar is powder coated yellow and is equipped with black markings to alert nearby forklift users and pedestrians.

The low profile design allows for easy access to the protected areas, keeping the collision protection low enough to allow access to pallet racking, machinery etc.

The collision protection bars can be bolted to the surface quickly and easily and provide instant protection to nearby assets.

Collision protection bars

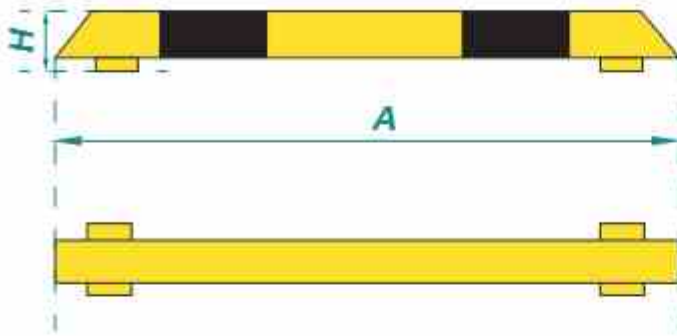

Symbol	Ø (mm)	H (mm)	A (mm)
CPB01	60.3	-	400,600,800,1000, 1200,1500,1800
CPB02	76.1		
CPB03	114.3		

Collision Protection Bars

are ideal for protecting shelving, cabinets, wall-mounted equipment (instruments, switch cabinets, first aid equipment etc.) and well as machinery or racking.

Key features:

- Material: black steel
- Coating: painted by method powder yellow with black reflective stripes
- Mounting: fastening to the ground with 12mm screws or 12mm anchors
- Base thickness: 8 mm

Corner collision protection bar

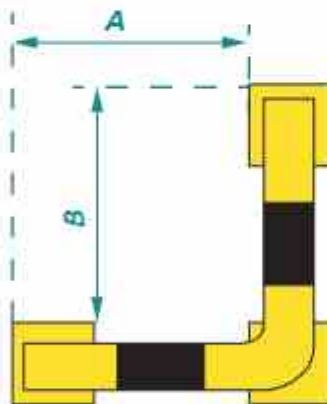

Symbol	Ø (mm)	A (mm)	B (mm)
C-CPB01	76.1	638	638

Collision protection bars

offer low cost, effective protection for plant and machinery from forklift trucks, roller containers, trolleys, pallet trucks etc.

Key features:

- Material: black steel
- Coating: painted by method powder yellow with black reflective stripes
- Mounting: fastening to the ground with 12mm screws or 12mm anchors
- Base thickness: 8 mm

Applications : Protect shelving, cabinets, wall-mounted equipment (instruments, switch cabinets, first aid equipment etc.).

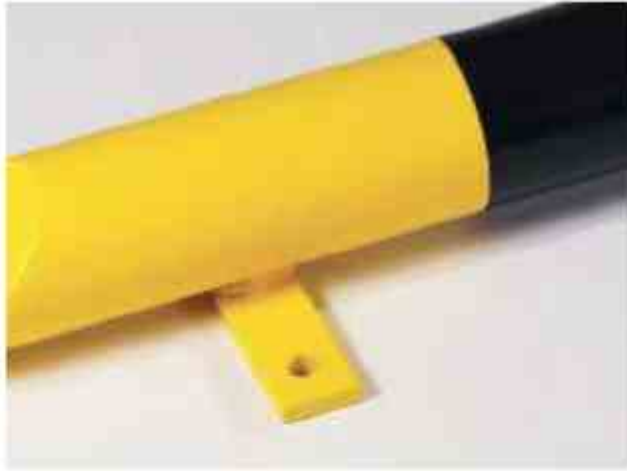



ELEKTRON



Wheel guides

Warehouse Partners can provide steel fabricated HGV vehicle wheel guides used to guide trailers onto loading docks which are available in both cranked & straight configurations for low level applications.

With the correct placement of wheel guides, safety, security and confidence for the HGV driver make these simple but effective solutions for your warehouse each loading dock can take several hundred movements of vehicles every week so its worth getting your protection just right.

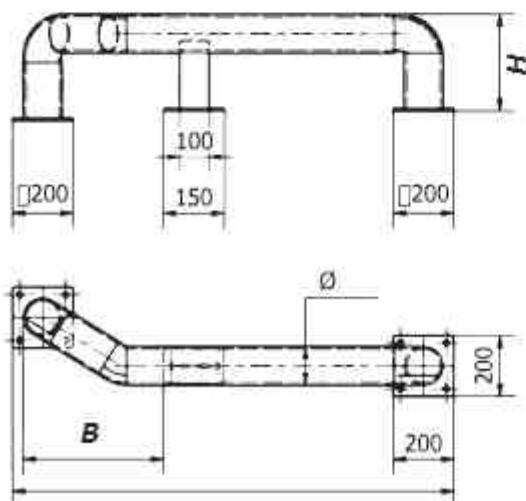

Wheel guides installed in front of the loading bay increase the safety and efficiency of loading and unloading operations. Wheel guides ensure that the vehicle approaches the loading bay centrally and straight.

Wheel guides



This pair of bolt down wheel guides are galvanized and yellow powder coated. Their splayed ends increase the effectiveness of this durable driver aid ensuring that trailers contact the loading dock squarely.

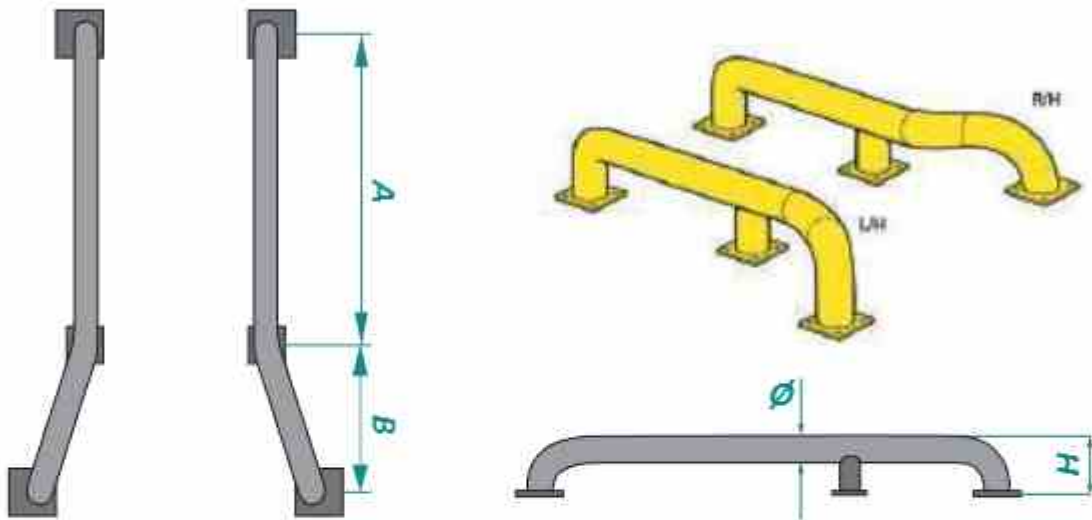

Symbol	Ø (mm)	H (mm)	A (mm)	B (mm)
WG01	159.6			
WG02	159.6	200,300,500	1000,1200,1500,	300,500,600,
WG03	159.6		1800,2000	1000
WG04	159.6			





Height limiters and gate protection

Hanging fender is designed to limit the height of e.g. entries to parking lots. Each has two or three holders (depending on the length) to which the chains holding the fenders are attached .

Application - warehouses, parking lots, ramps, etc.

Overhead Clearance Bars

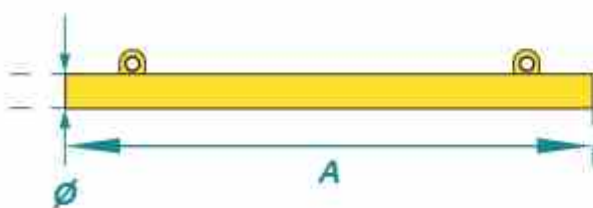

Symbol	Ø (mm)	A (mm)
HL01	48.3	1000,1200,1500, 1800,2000
HL02	60.3	
HL03	76.1	

Key features:

- Material: black steel
- Coating: painted by method powder yellow with black reflective stripes
- Installation: suspension on chains





Steel corner protection guards offer effective heavy duty protection of stock, traffic routes, for separating different traffic routes e.g. stacker lanes in warehouses and pedestrian traffic. Other uses are for protecting machinery, columns, shelving and loading ramps.

Each corner protection guard is made from the toughest German steel and is made to last - each indoor unit is powder coated yellow with black bands for the best in visibility in the likes of warehouses and freight depots.

The outdoor protection guards are made from hot-dip galvanised steel as well as being powder coated - helping to prevent rusting and corroding in the harshest of weather.

When installing the corner protection guards each unit is fitted with 3 base plates that allows for quick and easy installation into concrete where they are needed most.

Applications: Separates different traffic routes (e.g. stacker lanes in warehouses and pedestrian traffic). Protects stock, traffic routes and work areas, machinery, supports, columns, shelving, loading ramps, equipment etc.

L storage buffers

L storage buffers are made of solid steel. They cover the edges of shelving, machines and equipment located inside production and storage halls. They secure structural elements of industrial facilities.

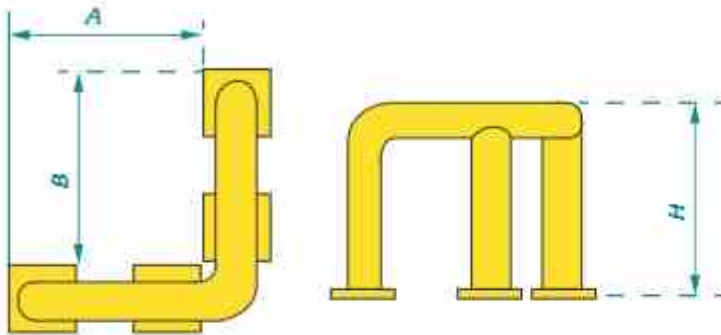

Key features:

- Material: black steel
- Coating: powder painted yellow with black reflective stripes
- Mounting: fixing to ground with 12mm screws or 12mm anchors
- Base thickness: 8 mm

Symbol	Ø (mm)	H (mm)	A (mm)	B (mm)
L-101	60.3	300		
L-102	60.3	600		
L-103	60.3	800	300,400,500,	300,400,500,
L-104	60.3	900	600,800,900,1000	600,800,900,1000
L-105	60.3	1000		
L-106	60.3	1200		

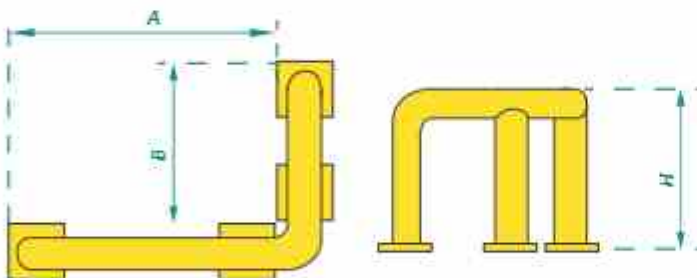

Key features:

- Material: black steel
- Coating: powder painted yellow with black reflective stripes
- Mounting: fixing to ground with 12mm screws or 12mm anchors
- Base thickness: 8 mm

Symbol	Ø (mm)	H (mm)	A (mm)	B (mm)
L-201	60.3	300		
L-202	60.3	600		
L-203	60.3	800	300,400,500,	300,400,500,
L-204	60.3	900	600,800,900,1000	600,800,900,1000
L-205	60.3	1000		
L-206	60.3	1200		



U-type fenders Buffers

used as protection for free-standing construction and wall poles. Mostly used in production, storage and parking halls. Their task is to protect corner elements from collision of forklift, car or other vehicle.

U bumper with two legs

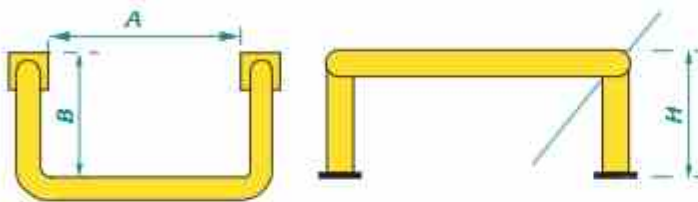

Key Features:

- Material: black steel
- Coating: painted by method powder yellow with black reflective stripes
- Mounting on two legs: fastening to the ground with 12mm screws or 12mm anchors
- Base thickness: 8 mm

Symbol	Ø (mm)	H (mm)	A (mm)	B (mm)
U-101	60.3	300,600,800,	300,400,500,	300,400,500,
U-102	76.1	1000	600,800	600

Three-leg U fender

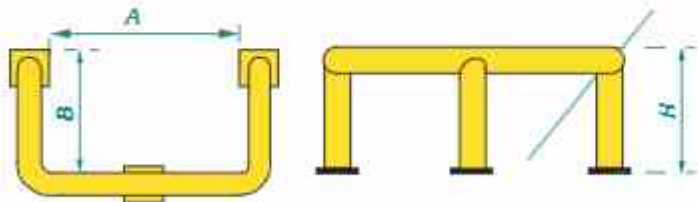

Key Features:

- Material: black steel
- Coating: painted by method powder yellow with black reflective stripes
- Mounting on three legs: fastening to the ground with 12mm screws or 12mm anchors
- Base thickness: 8 mm

Symbol	Ø (mm)	H (mm)	A (mm)	B (mm)
U-201	60.3	300,600,1000	200,250,300,400,500,	300
U-202	76.1		600,800,1000,1200	

Four-leg U fender

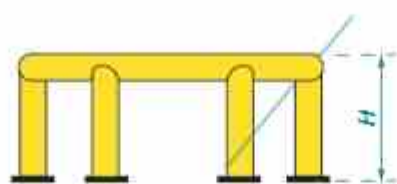
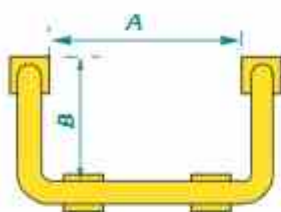

Key Features:

- Material: black steel
- Coating: painted by method powder yellow with black reflective stripes
- Mounting on four-legs: fastening to the ground with 12mm screws or 12mm anchors
- Base thickness: 8 mm

Symbol	Ø (mm)	H (mm)	A (mm)	B (mm)
U-301	60.3	300,600,800,	300,400,500,	300,400,500,
U-302	76.1	1000,1200	600	600



Protection hoops for gas pumps

Fender for gas stations, diameters and dimensions adapted to the needs of gas stations. We also make fenders of this type for individual customer orders.

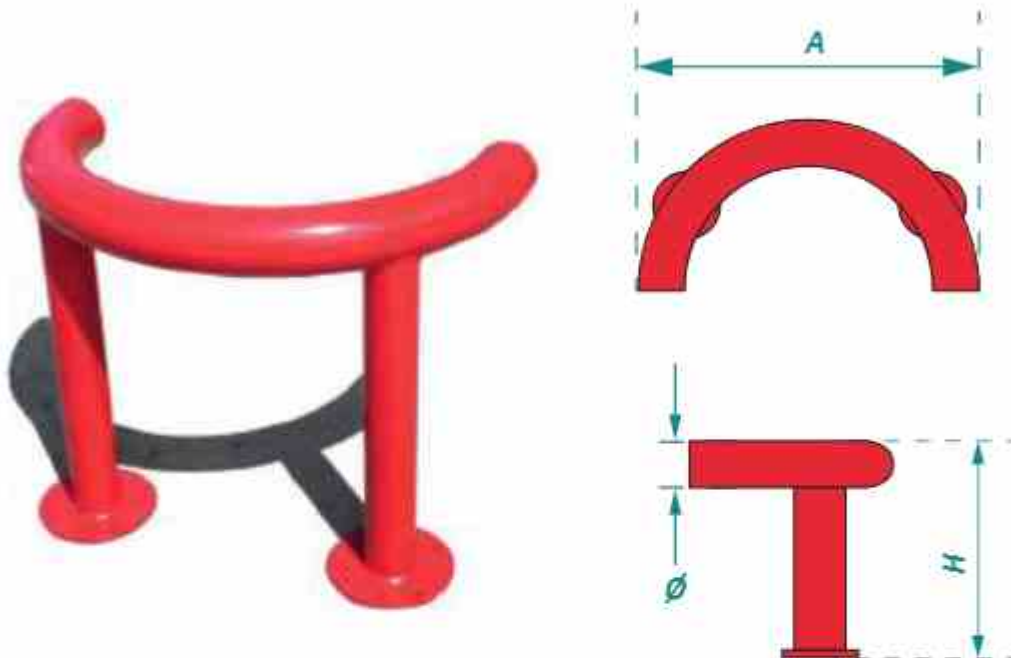

Symbol	∅ (mm)	H (mm)	A (mm)
GP01	114	750	900
GP02	106	750	900





ELEKTRON



Column & Post protectors

These highly versatile Column Protectors provide strong protection for vulnerable columns, exposed pipework etc. against damage by motorised transport.

Column Protectors are usually used for warehouses, logistic depots, street posts and trees, factories, public buildings etc.

- 'One way' assembly for easy installation
- Strong steel construction
- Isolates column from impact shock
- Highly visible versions
- Anchor Plates have 2 drilled holes per plate
- Suitable for indoor and outdoor use

Robust steel guard to protect pillars or columns. The pillar guard is available in two variations: for indoor (powder coated) or outdoor use (galvanised and powder coated). Its yellow and black colour combination ensures the pillar guard is clearly visible.

Column & Post Protectors

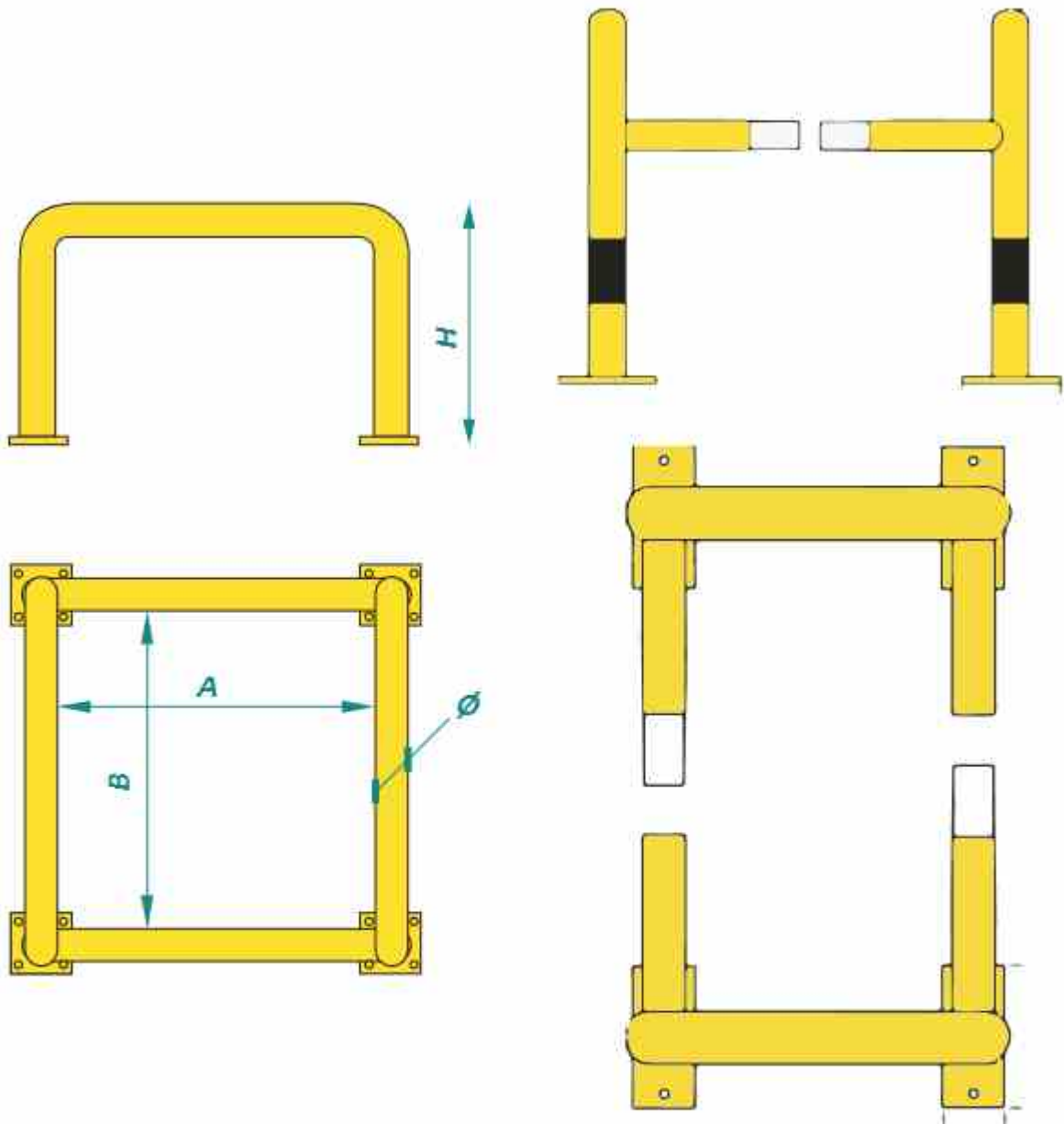

Symbol	Ø (mm)	H (mm)	A (mm)	B (mm)
CPP01	60.3	400	500,600,700,800	500,600,700,800
CPP02	60.3	600		
CPP03	60.3	800		
CPP04	60.3	1000		
CPP05	60.3	1200		





Vertical Pipe Protectors also protect against accidental damage by passing vehicles.

- Protection for exposed down pipes, cables and cable runs against accidental damage from fork-lift trucks and other vehicles
- 'U' shaped profile with 4 keyhole slots for easy installation
- Manufactured from high grade steel
- Internal or external use options available
- Outdoor options available in either raw galvanised or galvanised and powder coated bright yellow with black bands
- Indoor options powder coated bright yellow with black bands

Applications : Factories, Warehouses, Public Buildings, Office Blocks etc.

Floor mounted vertical pipe protectors

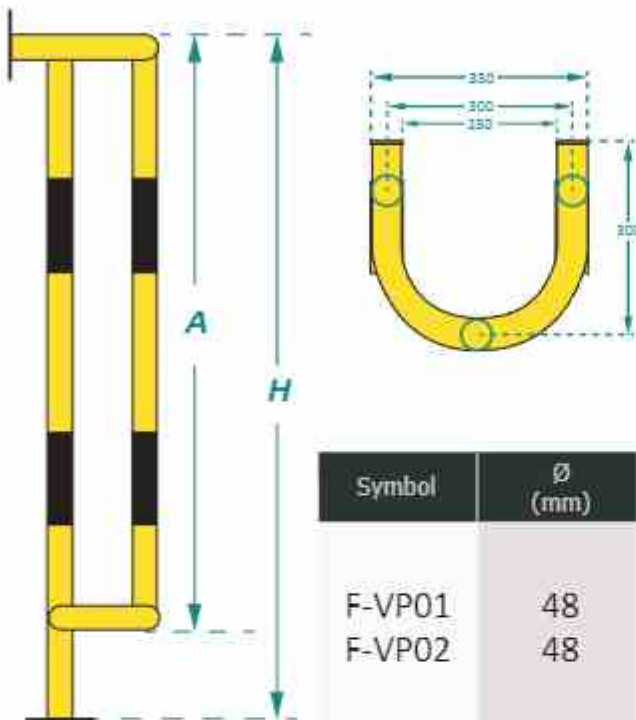

Key features:

- Material: black steel
- Coating: painted by method powder yellow with black reflective stripes
- Installation: wall mounting with 12mm screws or 12mm anchors
- Base thickness: 8 mm

Symbol	Ø (mm)	H (mm)	A (mm)	W (mm)	D (mm)
F-VP01	48	1500	1300	350	300
F-VP02	48	1000	800	350	300

Wall mounted vertical pipe protectors

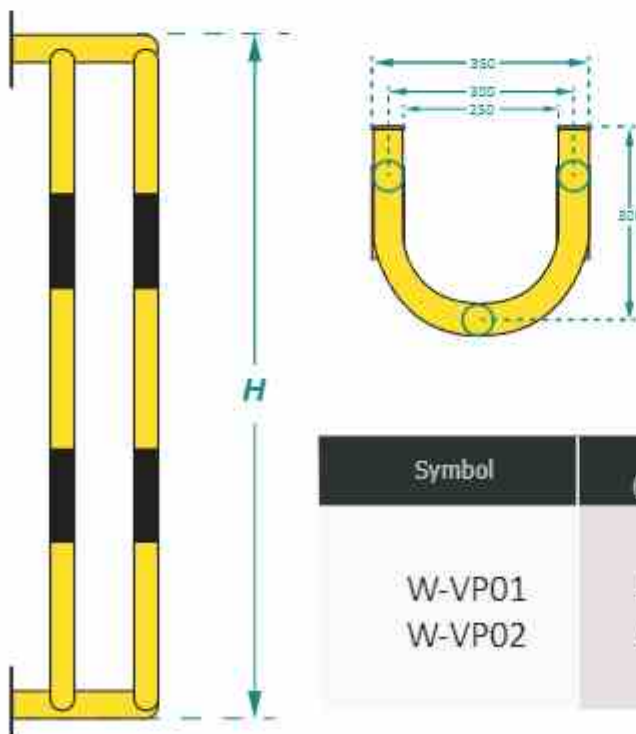

Key features:

- Material: black steel
- Coating: painted by method powder yellow with black reflective stripes
- Installation: wall mounting with 12mm screws or 12mm anchors
- Base thickness: 8 mm

Symbol	Ø (mm)	H (mm)	W (mm)	D (mm)
W-VP01	48	1500	350	300
W-VP02	48	1000	350	300





Pallet racking protectors

Provides excellent protection to the likes of pallet racking, corners or columns that may be in place in warehouses and other such areas, helping to reduce or prevent damage that may occur. These pallet rack protectors are required for fixed racking installations where industrial trucks are used (except where they are guided by rails). Pallet Racking Protectors provide the ideal solution in most situations. They can also be used to protect machinery, partition systems, rectangular columns etc.

Easy to install, these pallet rack protectors can be bolted directly into the ground and provide instant protection to nearby assets. Each unit is powder coated yellow to provide excellent visibility while they are in use in a workplace, with black markings for a hazards or warning type design that is sure to catch the attention of nearby employees.

These pallet rack protectors come in a right-angle version that can help to protect assets on two sides while the u-shaped profiles can protect assets three sides.

Right-angle: Two way protection.

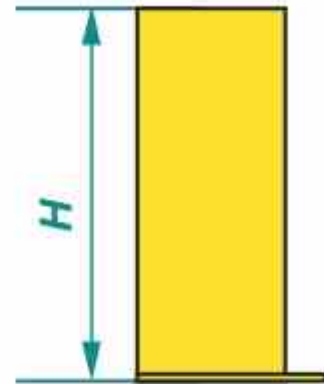
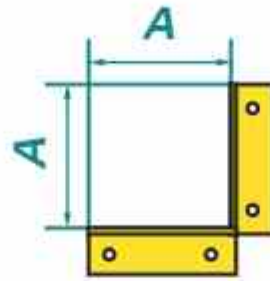

Symbol	\varnothing (mm)	H (mm)	A (mm)	B (mm)
RG-PR	-	400,500,600, 800,1000,1500	125,150,200, 300,400	125,150,200, 300,400

U-profile: Three way protection.

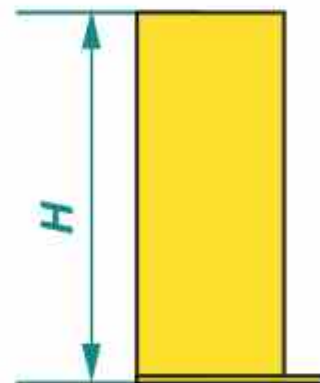
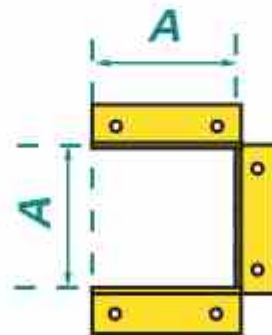

Symbol	\varnothing (mm)	H (mm)	A (mm)	B (mm)
UP-PR	-	400,500,600, 800,1000,1500	125,150,200, 300,400	125,150,200, 300,400

Surface treatment: Powder coated yellow with black striping.



Shelf fender made of flat sheet metal



Sheet metal fenders are used to cover storage racks fitted at workplaces . They protect sensitive areas from the possibility of contact with vehicles moving in warehouses, shop halls, as well as all production areas.

Buffers are made of sheet metal with a thickness of 4 or 6 mm as standard. However, it is also possible to make a rack fender from sheet metal of a different thickness and non-standard dimensions, depending on the needs and the place of its application. In order to obtain an individual quote.

The offer includes flat sheets and "L" and "U" fenders. They can be used together to ensure maximum protection of the racks against potential contact with vehicles that move along storage avenues or the spaces of halls in which the racks are located.

All fenders in the standard version are powder painted yellow and covered with black foil . This colour combination makes sensitive areas very visible and at the same time properly protected.

Steel fenders help minimize the risk of damage to the rack legs. They can also be used in places with which no equipment, vehicles or machines should have contact.

Symbol	Thickness (mm)	H (mm)	w (mm)
FM01	4	400,1000	400,1000
FM02	6		

CONTACT



WE INVITE YOU TO CONTACT:
ELEKTRON sp. z o.o. sp.k.



Customer service hours:

Monday - Friday, 7:00 am - 4:00 pm



38-462 Kobylany, Sulistrowa 33

CUSTOMER SERVICE OFFICE



+48 13 307 03 03



SHEET LASER CUTTING:

laser@web-elektron.pl



OFFICE:

biuro@web-elektron.pl



www.web-elektron.pl



NIP: 6842640074



REGON: 360939126



KRS: 0000749874

