

### BICYCLE-STAND 450-1

Steel + Stainless steel | 845 mm

#### Specifications

Frame made from bent steel tubes with a 42.4 x 2.5 mm diameter, a vertical rear tube, and mutually offset tube ends.

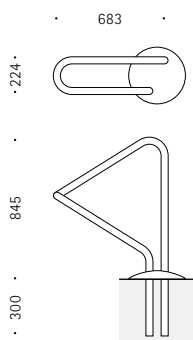

|       |                           | Bicycle stand | Cover plate (optional) |
|-------|---------------------------|---------------|------------------------|
| 450-1 | Steel ST37, galvanised    | 450.001       | 455.001                |
| 450-1 | Steel ST37, powder-coated | 450.011       | 455.011                |
| 450-1 | Stainless steel 1.4301    | 450.002       | 455.002                |

Ground shell for removable model: **456.002**



### BICYCLE-STAND 450-2

Steel + Stainless steel | 845 mm

#### Specifications

Frame made from bent steel tubes with a 42.4 x 2.5 mm diameter, an overhanging rear tube, as well as mutually offset tube ends.

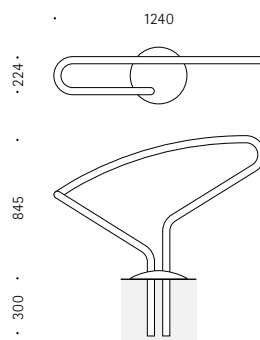

|       |                           | Bicycle stand | Cover plate (optional) |
|-------|---------------------------|---------------|------------------------|
| 450-2 | Steel ST37, galvanised    | 450.003       | 455.001                |
| 450-2 | Steel ST37, powder-coated | 450.013       | 455.011                |
| 450-2 | Stainless steel 1.4301    | 450.004       | 455.002                |

Ground shell for removable model: **456.002**





## BICYCLE-STAND 451

Steel + Stainless steel | 855 mm

### Specifications

Frame made from bent steel tubes with a 42.4 × 2.5 mm diameter and parallel tube ends.

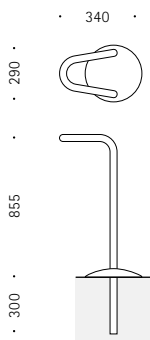

### Mounting

- Concrete embedment (only one foundation required)
- Alternative: removable with ground shell
- Optional: convex cover plate with a 300 mm diameter

### Finish

- Stainless steel 1.4301 pickled and smoothed, grain 240  
Optional: electropolished/high-gloss (no surcharge)
- Steel ST37, galvanised with powder coating in standard RAL colours or DB 703
- Other colours available on request at a surcharge

### Note

For the removable version, the cover plate is needed.

|     |                           | Bicycle stand | Cover plate (optional) |
|-----|---------------------------|---------------|------------------------|
| 451 | Steel ST37, galvanised    | 451.003       | 455.003                |
| 451 | Steel ST37, powder-coated | 451.013       | 455.013                |
| 451 | Stainless steel 1.4301    | 451.004       | 455.004                |

Ground shell for removable model: 456.003

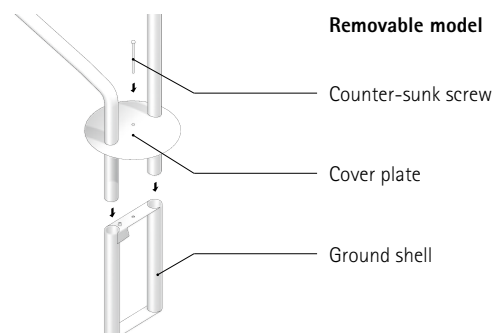

**BICYCLE-STAND 450 451**

**Sample configurations**

These examples for designing parking areas with the ABES Bicycle-Stand 450 or 451 may serve as inspiration for the variety of configuration options.

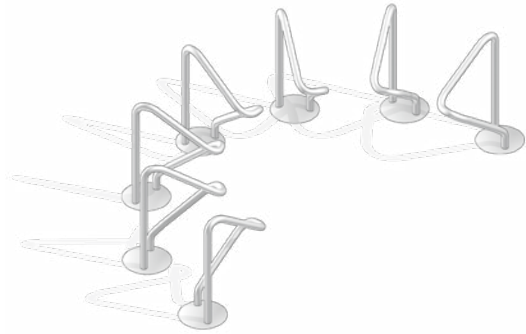

Diagonal

Diagonal 180°

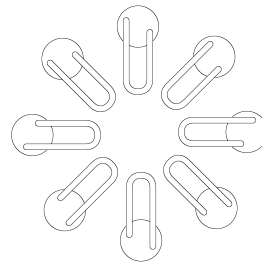
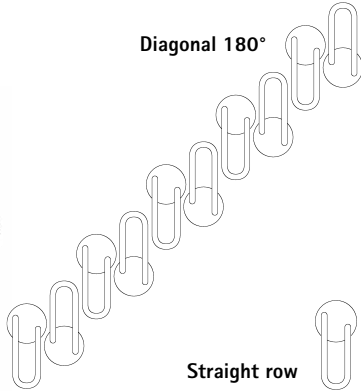

Circle of 8 bicycle stands

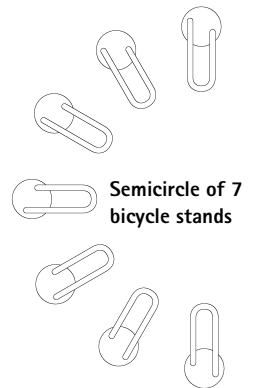

Semicircle of 7 bicycle stands

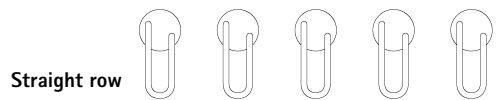

Straight row

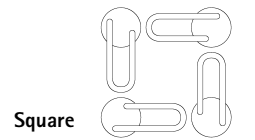

Square



1

**1 Bicycle-Stand 450-5**

*Powder-coated,  
DB703 glimmer grey*

**2 Bicycle-Stand 450-1**

*Powder-coated,  
DB703 glimmer grey*

**3 Bicycle-Stand 450-2**

*Powder-coated,  
DB703 glimmer grey*



3



2



Alle Größenangaben in mm und alle Gewichtsangaben in kg