

HOHLSTEMMAGGREGAT – CLASSIC LINE RENITO H

TECHNISCHE DATEN

Schmierung	Fett
max. Abtriebsdrehzahl n_2	1.000 min ⁻¹
Übersetzung ($n_1: n_2$)	1:0,73
max. Abtriebsdrehmoment M_2	22 Nm
Gewicht	ca. 4,5 kg

STANDARDAUSFÜHRUNG

- 1  Maschinenanbindung
HSK - F63
- 2  **10** Stemmquerschnitt

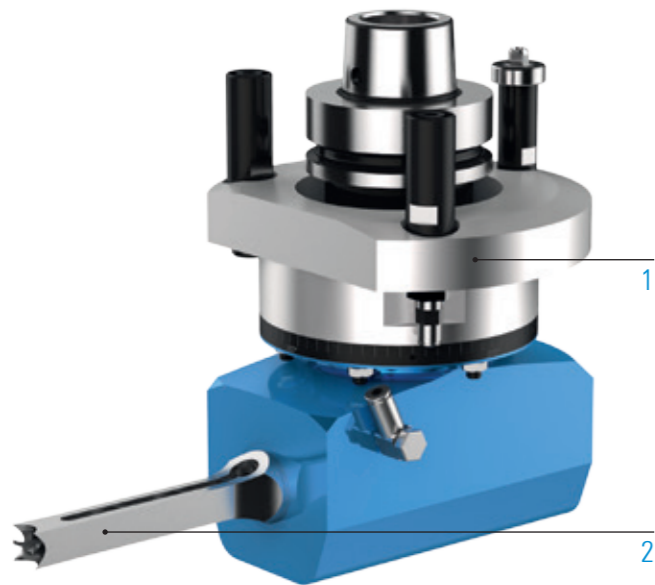

WEITERE OPTIONEN: MODULARER AUFBAU

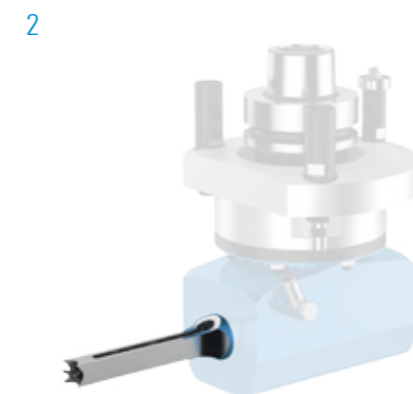

MASCHINENANBINDUNG



 Weitere Informationen S. 106

STEMMQUERSCHNITT







 Weitere Stemmquerschnitte auf Anfrage

BEARBEITUNG



SPEZIFIKATIONEN

-  Anzahl
Werkzeugaufnahmen
-  Achswinkel
-  C-Winkel
-  Fettschmierung

VIDEO

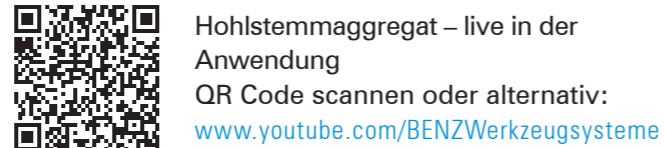

DIREKT BESTELLEN

