



- Acc. to DIN EN 61810-1, DIN EN 61810-3 (Type A), DIN EN 50578 (UIC 736)
- With forcibly guided contacts
- High switching reliability due to crown contacts
- Low rated power consumption
- High mechanical service life
- High continuous thermal current  $I_{th} = 8 \text{ A}$
- Compact size

## Anwendungen

- To be used in electrical circuits for safety applications.
- For railway signalling circuits according to DIN EN 50578 (UIC 736 R: 2004)

## Approvals and Markings

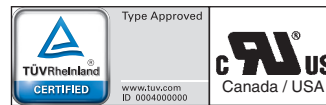

## Technical Data

Relay type		OA 5611	
<b>1.0 Relay coil</b>			
1.1 Nominal voltage	DC V	6, 12, 24, 48, 60, 110 (others on request)	
1.2 Nominal consumption	W	0.7	
1.11 Voltage range	$U_N$	0.75 ... 1.4	
1.13 Holding power (at 0.5 $U_N$ )	W	0.18	
1.14 Airgap in magnetic circuit	mm	> 0.1	
<b>2.0 Contacts</b>			
2.1 Contact arrangement (Type A)		2 NO / 2 NC 3 NO / 1 NC	
2.2 Contact material		AgSnO <sub>2</sub> + 0.2 μm Au; AgNi + 0.2 μm Au, AgNi + 5 μm Au	
2.3 Rated insulation voltage	AC V	250	
Switching voltage min./max.	V	AC/DC 10 / DC 250, AC 400 (AC/DC 2 V / 60 V) <sup>1)</sup>	
2.4 Limiting continuous current $I_{th}$	A	3 x 8 (see operating voltage limit curve)	
Switching current min./max.	A	> 10 mA <sup>3)</sup> / 8 (2 mA / 0.3 A) <sup>1)</sup>	
2.5 Switching power min./max.	VA	0.1 / 2000 (10 mVA / 12 VA) <sup>1)</sup>	
Switching power min./max	W	0.1 <sup>3)</sup> / 200 (10 mW / 12 W) <sup>1)</sup> (see limit curve for arc-free operation)	
2.6 Switching capacity to IEC/EN 60947-5-1		B300	
AC 15 <sup>4)</sup>	AC V/A	NO: 250 / 2	NC: 250 / 1
AC 15 <sup>5)</sup>	AC V/A	NO: 250 / 3	NC: 250 / 2
DC 13 <sup>4)</sup>	DC V/A	NO: 24 / 1	NC: 24 / 1
DC 13 <sup>4)</sup> at 0.1 Hz	DC V/A	NO: 24 / 4	NC: 24 / 4
to UL 508			
2.7 Electrical life		at 1 s On, 1 s Off (see contacts service life)	
at AC 230 V, 5 A, $\cos\phi = 1$	switching cycles	> 3 x 10 <sup>5</sup> AgSnO <sub>2</sub>	> 2 x 10 <sup>5</sup> AgNi 10
at AC 230 V, 8 A, $\cos\phi = 1$	switching cycles	> 1.5 x 10 <sup>5</sup> AgSnO <sub>2</sub>	> 10 <sup>5</sup> AgNi 10
2.8 Switching frequency max	switching cycles / s	10	
2.9 Response time / Release time	ms	typically 20 / typically 6	
2.10 Contact force	cN	≥ 15	
2.14 Contact gap	mm	> 0.5 <sup>2)</sup>	
<b>3.0 Other</b>			
3.1 Mechanical life	switching cycles	≥ 10 <sup>7</sup>	
3.2 Temperature range	°C	- 40 ... + 70	
3.3 Degree of protection, housing		Solder line proof RT II	
3.4 Test procedure		A (group mounting)	
3.5 Vibration resistance		5 ... 55 Hz; amplitude; 2 g max. IEC/EN 60068-2-6	
3.6 Climate resistance		40 / 070 / 04; A / B / D IEC/EN 60068-1	
3.7 Short circuit strength 1 kA / AC 250 V	AgSnO <sub>2</sub> AgNi	NO: 10 A gL / NC: 10 A gL IEC/EN 60947-5-1 NO: 6 A gL / NC: 6 A gL IEC/EN 60947-5-1	

<sup>1)</sup> Values for AgNi-contacts + 5 μm Au

<sup>3)</sup> Typical values for AgSnO<sub>2</sub> and AgNi

<sup>2)</sup> over entire service life, even when under fault and at 1.4 x  $U_N$

<sup>4)</sup> Values for AgNi-Contacts

<sup>5)</sup> Values for AgSnO<sub>2</sub>-contacts

## Technical Data

3.8	Insulation acc. to IEC 60664-1, EN 50178		
	Rated insulation voltage	AC V	250
	Pollution degree		3
	Overtoltage category		III
	Test voltage		
	Contact-coil (1 min)	AC kV eff.	≥ 4
	Contact-contact (1min)	AC kV eff.	≥ 2.5
	Open contact acc. to DIN EN 61810-1	AC kV eff.	1.5
	Transient voltage		
	Contact-coil (1,2 - 50 μs)	kV	≥ 6
	Clearance and creepage distances		
	Contact - Coil	mm	≥ 8
	Contact side-Contact side	mm	≥ 4,5
	Contact - Contact	mm	≥ 4,5
3.9	Weight	g	approx. 35
<b>4.0 Packing</b>			
4.1	on cardboard	piece	30
4.2	in case package	piece	150
<b>5.0 Solder method</b>			
5.1	Solder method /-temperature /-duration	°C / s	Wave soldering / 260 / 5

## Design Versions

OA 5611				
U <sub>N</sub> (DC V)	Voltage range (DC V)	R <sub>Spule</sub> Ω ± 10%	.48	.52
			3NO / 1NC	2NO / 2NC
AgNi-contacts + 0,2 μm Au				
6	4,5 ... 8,4	51	3121	3101
12	9,0 ... 16,8	205	3122	3102
24	18,0 ... 33,6	805	3123	3103
48	36,0 ... 67,2	3 290	3124	3104
60	45,0 ... 84,0	5 150	3125	3105
110	82,5 ... 154,0	17 300	3126	3106
AgNi-contacts + 5 μm Au				
6	4,5 ... 8,4	51	3131	3111
12	9,0 ... 16,8	205	3132	3112
24	18,0 ... 33,6	805	3133	3113
48	36,0 ... 67,2	3 290	3134	3114
60	45,0 ... 84,0	5 150	3135	3115
110	82,5 ... 154,0	17 300	3136	3116

## Ordering Example

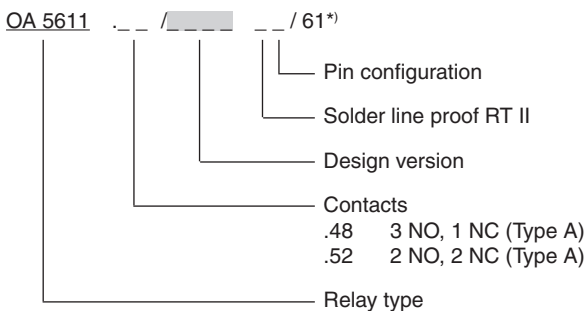

\*) / 61 cURus approval

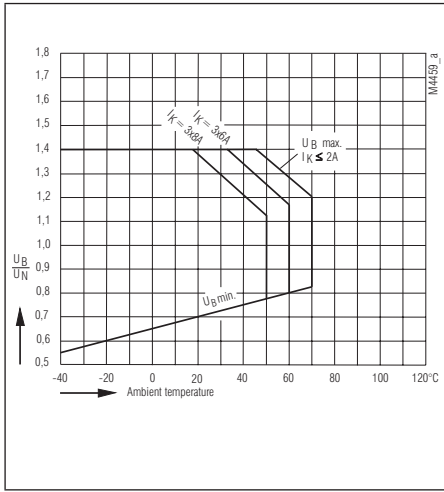

Operating voltage limit curve OA 5611

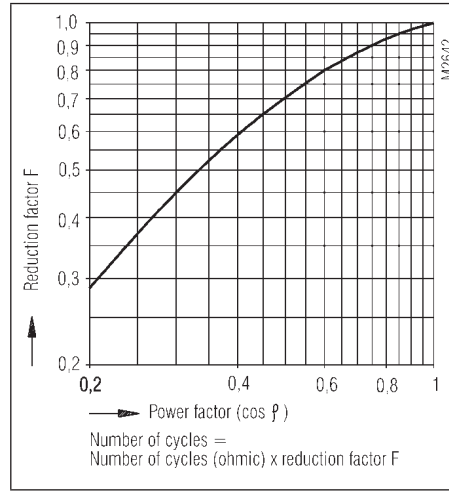

Reduction factor for inductive loads

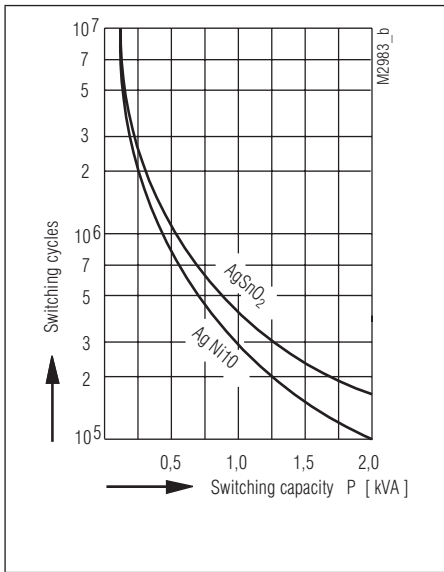

Contact service life

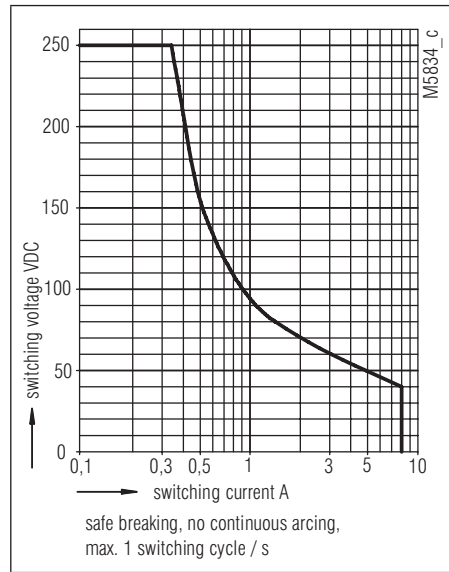

Arc limit curve (load limit curve)

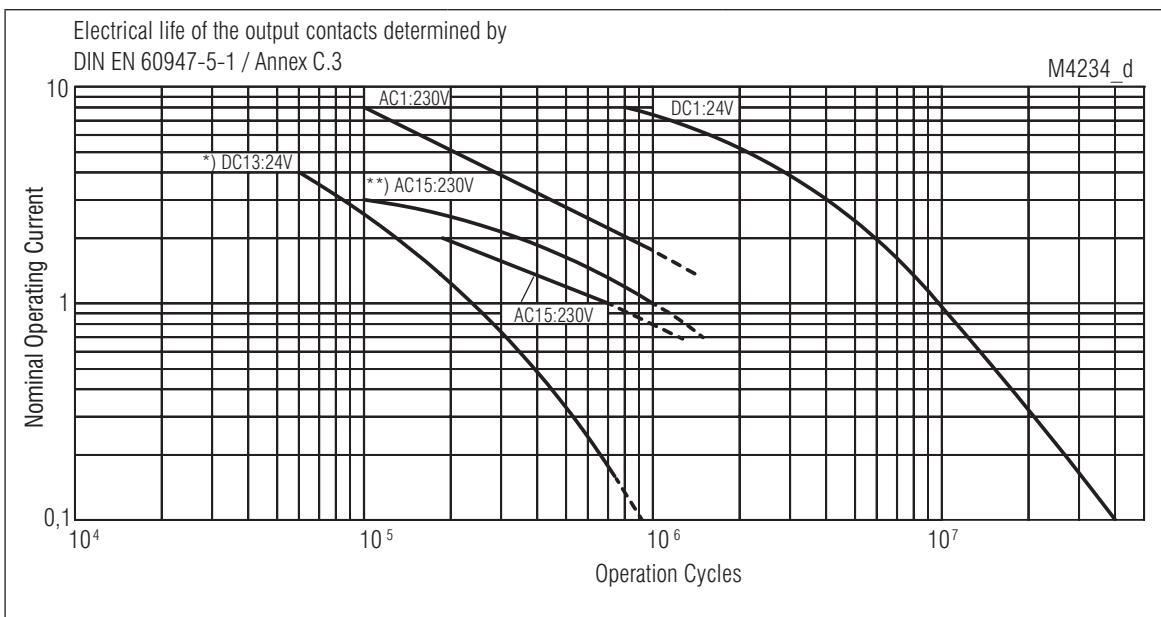

Electrical life for contact material AgNi  
 \*) ≤ 1 A with 1 Hz  
 > 1 A ... 4 A with 0.1 Hz  
 \*\*) for AgSnO<sub>2</sub>

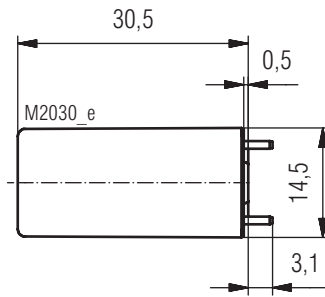
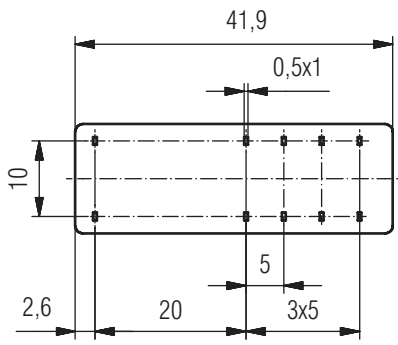

Drilling plan (solder side)

Pin arrangement OA 5611.52/...L1 2NO / 2NC

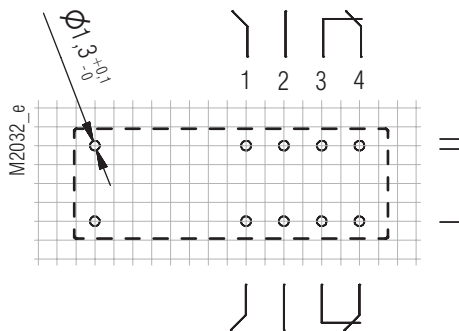

Pin arrangement OA 5611.52/...L4 2NO / 2NC

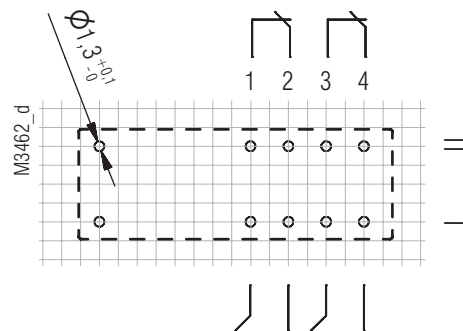

Pin arrangement OA 5611.52/...L5 2NO / 2NC

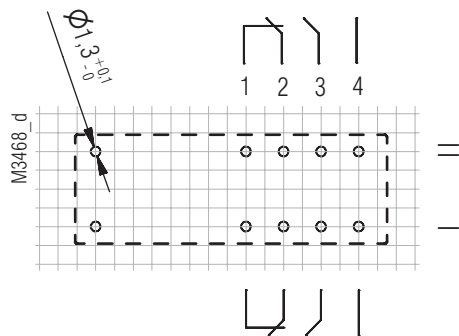

Pin arrangement OA 5611.48/...L1 3NO / 1NC

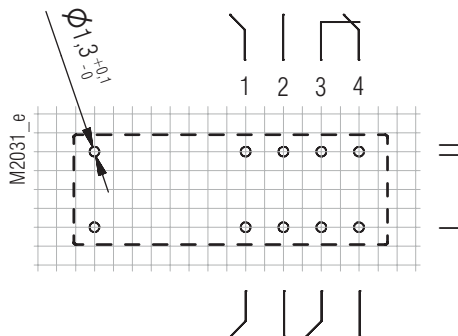

Pin arrangement OA 5611.48/...L4 3NO / 1NC

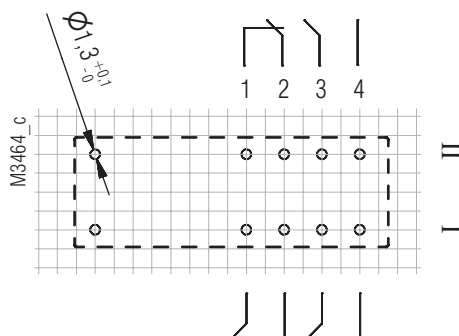

Pin arrangement OA 5611.28 1NO / 3NC

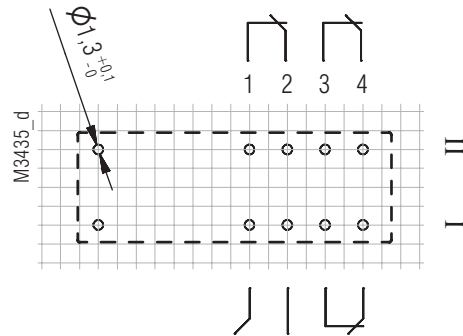

Connection for basic grid dimensions 2.5 mm as well as 2.54 mm according to IEC/EN 60097 and IEC 60326 average

Relay socket ET 1415.031/61 for OA 5611

Article number: 0049512

