

## Product information

### mzr-4622 · Low pressure pump series



#### Description

The compact micro annular gear pump mzr-4622 of the low pressure series is an innovative pump concept for use in analytical instrumentation. The pump generates a low pulsation, highly precise flow featuring low shear stress. It dispenses at a high precision the lowest volumes in microliter range. Due to its compact design small dimensions have been achieved. The pump is suitable for dosage of low viscosity liquids such as deionized water, watery solutions, methanol, solvents, oil and lubricants.

#### Advantages

- Compact dimensions  
diameter 18 mm, length 88 mm
- Small dosage volumes, high flow rates  
smallest volume 2 µl – flow up to 72 ml/min
- High dosage precision  
precision CV 1 % at low volumes
- Long service life  
wear-resistant tungsten carbide
- Low pulsation delivery, low shear stress  
rotary micro annular gear technology

#### Applications

- Analytical instrumentation
- Laboratory automation
- Fuel cells
- In vitro diagnostics

## Technical data

|                             |  |
|-----------------------------|--|
| Flow rate                   | 1.2 - 72 (min. 0.012*)ml/min   |
| Smallest dosage volume      | 2µl  |
| Displacement volume         | 12µl   |
| Differential pressure range | 0 - 5 bar (73 psi)   |
| Maximum inlet pressure      | 1 bar (15 psi)   |
| Liquid temperature range    | -20 ... +60 °C (-4 ... +140 °F)  |
| Viscosity range             | 0.3 – 100 (max. 1,000*)mPas  |
| Precision CV                | 1% (Coefficient of variation CV)   |
| Velocity range              | 100 – 6,000 (min. 1*)rpm   |
| Fluid connection            | slip fittings with outside diameter 2 mm optional: manifold assembly   |
| Wetted parts                | stainless steel 316L, ceramics, tungsten carbide Ni based, epoxy resin, optional: alloy C22 (2.4602) instead of stainless steel, ceramics instead of tungsten carbide; shaft seal: graphite-reinforced PTFE, stainless steel 316L, optional: alloy C276 (2.4819) instead of stainless steel; static seals: FPM, optional: EPDM, FFPM |
| Motor                       | DC-motor with graphite brushes, assigned power rating 4.5 W, nominal voltage 24 V, digital magnet encoder 32 counts per turn   |
| Electrical connection       | 10-pole connector  |
| Dimensions (L x W x H)      | Ø 18 mm, length 88 mm  |
| Weight                      | approx. 100g   |
| Remarks                     | * depending on accessories, Customized solutions on request  |

### Notice

Even if single parameters are within the indicated performance range of technical data, certain parameter combinations may not be achievable. Single parameters may exceed their indicated performance range under adequate circumstances. For detailed evaluation please contact HNP Mikrosysteme. Actual performance may vary. Specifications are subject to change without notice.

## Accessories

- Reduction gear
- S-KG
- S-ND
- m zr-Touch Control

## Dimensions

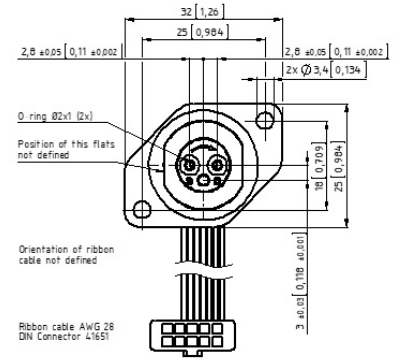
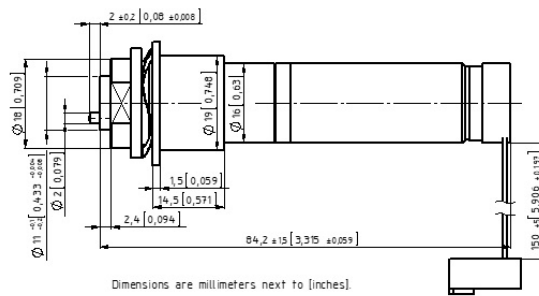
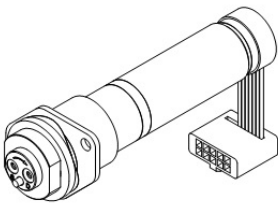
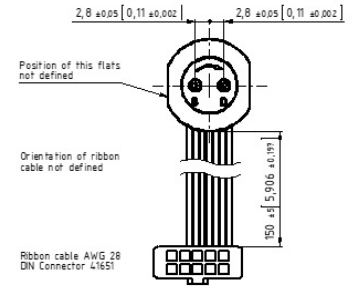
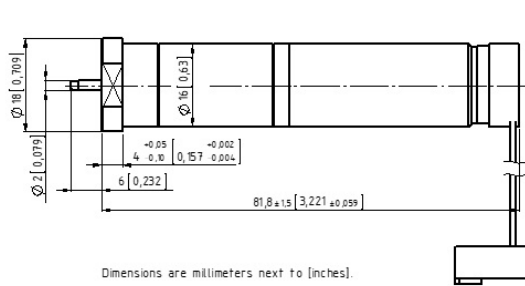
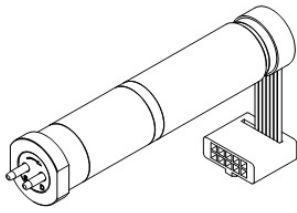

## Flow charts

Liquid water

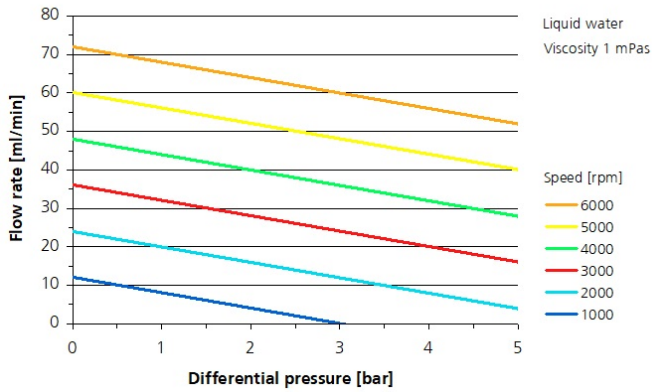

Liquid oil

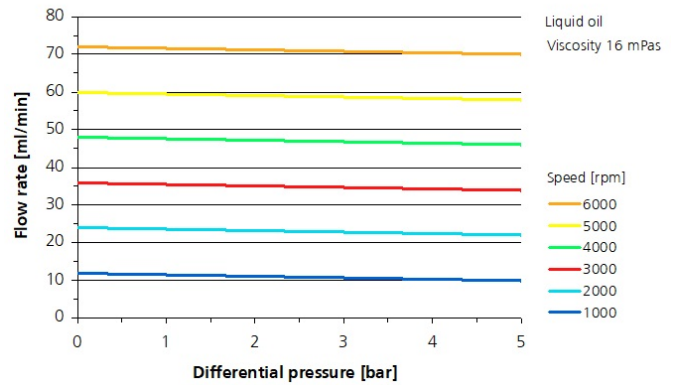

## Patents and trademarks

Micro annular gear pumps (and housings) are protected by assigned patents: EP 1 354 135 B1; US 7,698,818 B2; DE 10 2011 001 041 B4; CN 103 348 141 B; US 10,012,220 B2; CN 103 732 921 B; US 9,404,492 B2; US 6,520,757 B1.  
HNP M<sup>®</sup>, mzt<sup>®</sup>, MoDoS<sup>®</sup>,  $\mu$ -Clamp<sup>®</sup>,  $\mu$ Dispense<sup>®</sup>, Centifluidic Technologies<sup>®</sup>, LiquiDoS<sup>®</sup>, smartDoS<sup>®</sup>, ColorDoS<sup>®</sup> are registered German trademarks of HNP Mikrosysteme GmbH.

## Contact

HNP Mikrosysteme GmbH  
Bleicherufer 25  
19053 Schwerin  
Germany

T +49 385 52190-300  
F +49 385 52190-333  
info@hnp-mikrosysteme.de

Last update 2019/09