

Profil 2

Artikel-Nr.	Qualität*	Härte Shore A*	Farbe*	Verkaufseinheit*	Mindestabnahmemenge
2	PVC weich	57	braun, schwarz, transparent	100 m Rollen	1.000 m

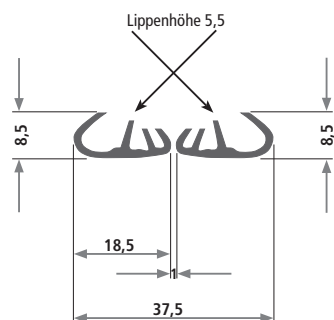

Profil 6

Artikel-Nr.	Qualität*	Härte Shore A*	Farbe*	Verkaufseinheit*	Mindestabnahmemenge
6	PVC weich	57	rotbraun, schwarz	60 m Rollen	2.000 m

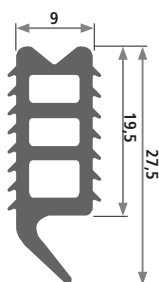

Profil 263

Artikel-Nr.	Qualität*	Härte Shore A*	Farbe*	Verkaufseinheit*	Mindestabnahmemenge
263	PVC weich	57	schwarz	20 m	1.000 m

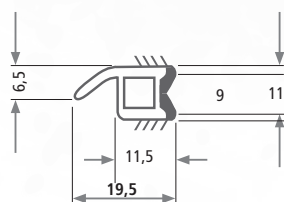
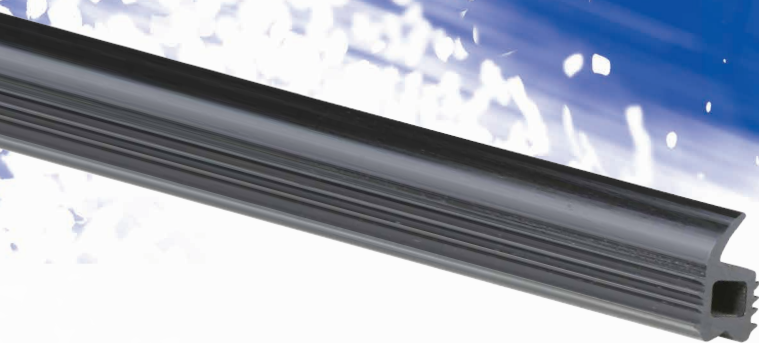

Profil 273

Artikel-Nr.	Qualität*	Härte Shore A*	Farbe*	Verkaufseinheit*	Mindestabnahmemenge
273	PVC weich	57	schwarz	20 m	4.000 m

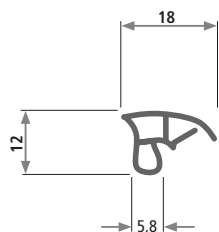

Profil 370

Artikel-Nr.	Qualität*	Härte Shore A*	Farbe*	Verkaufseinheit*	Mindestabnahmemenge
370	PVC weich	57	grau	75 m	2.000 m

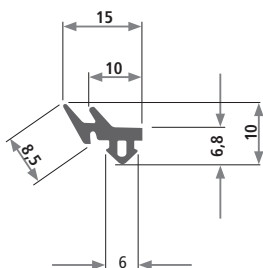

Profil 642

Artikel-Nr.	Qualität*	Härte Shore A*	Farbe*	Verkaufseinheit*	Mindestabnahmemenge
642	PVC weich	57	schwarz	100 m	2.500 m

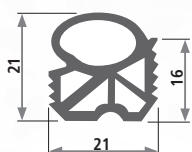
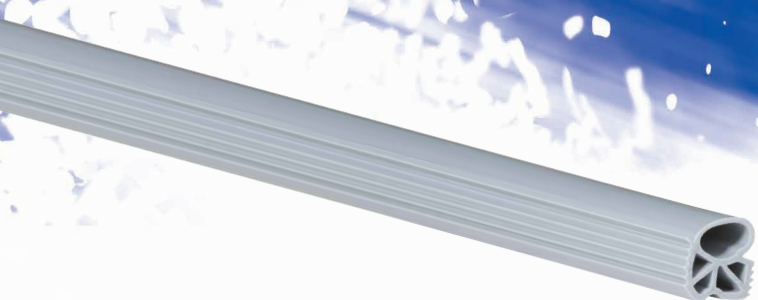

Profil 1067

Artikel-Nr.	Qualität*	Härte Shore A*	Farbe*	Verkaufseinheit*	Mindestabnahmemenge
1067	PVC weich	57	grau	40 m Rollen	4.000 m

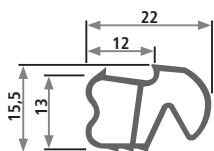

Profil 1501

Artikel-Nr.	Qualität*	Härte Shore A*	Farbe*	Verkaufseinheit*	Mindestabnahmemenge
1501	PVC weich	57	schwarz	50 m Rollen	2.000 m

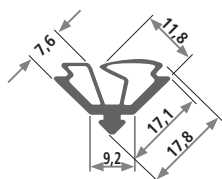

Profil 2526

Artikel-Nr.	Qualität*	Härte Shore A*	Farbe*	Verkaufseinheit*	Mindestabnahmemenge
2526	PVC weich	60	schwarz	50 m Rollen	1.000 m

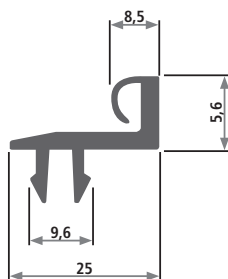

Profil 2558

Artikel-Nr.	Qualität*	Härte Shore A*	Farbe*	Verkaufseinheit*	Mindestabnahmemenge
2558	PP 20 % talkum- verstärkt TPE	62 D	grau	Fixlänge von 3.010 mm	2.500 m
		45 A			